

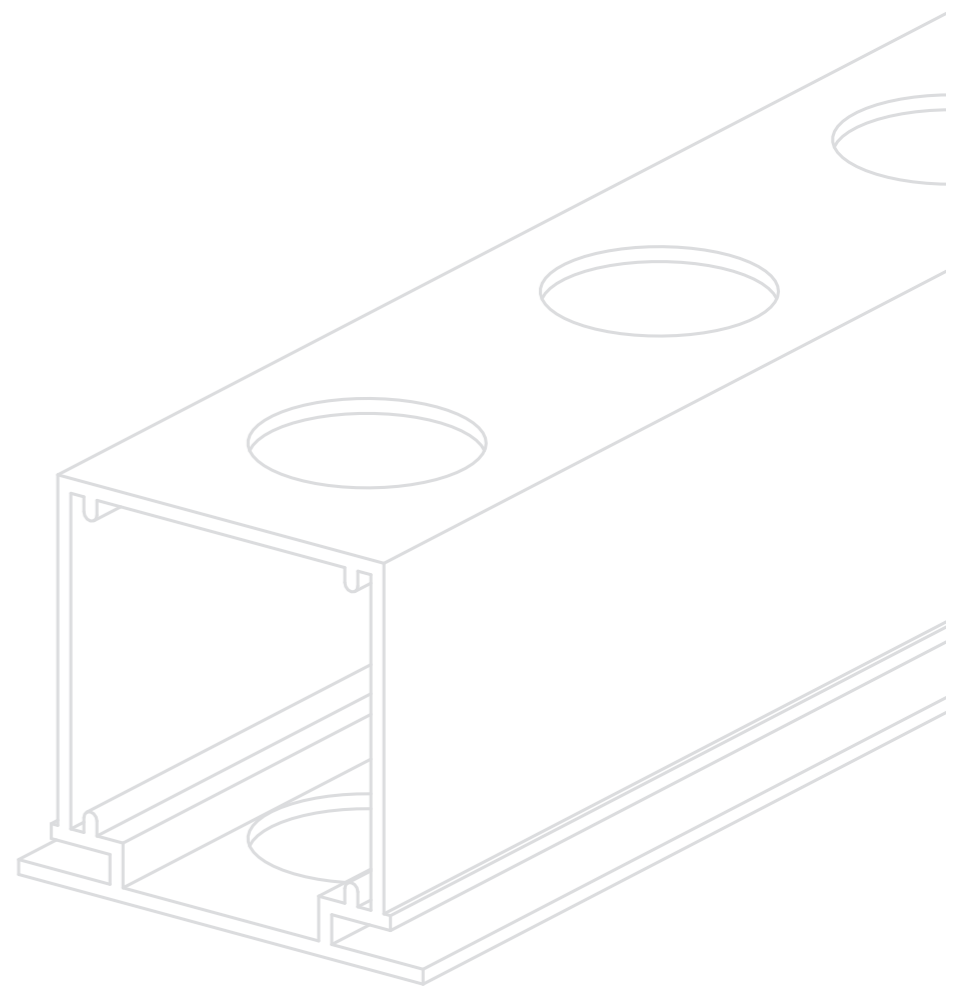

M-SERIES

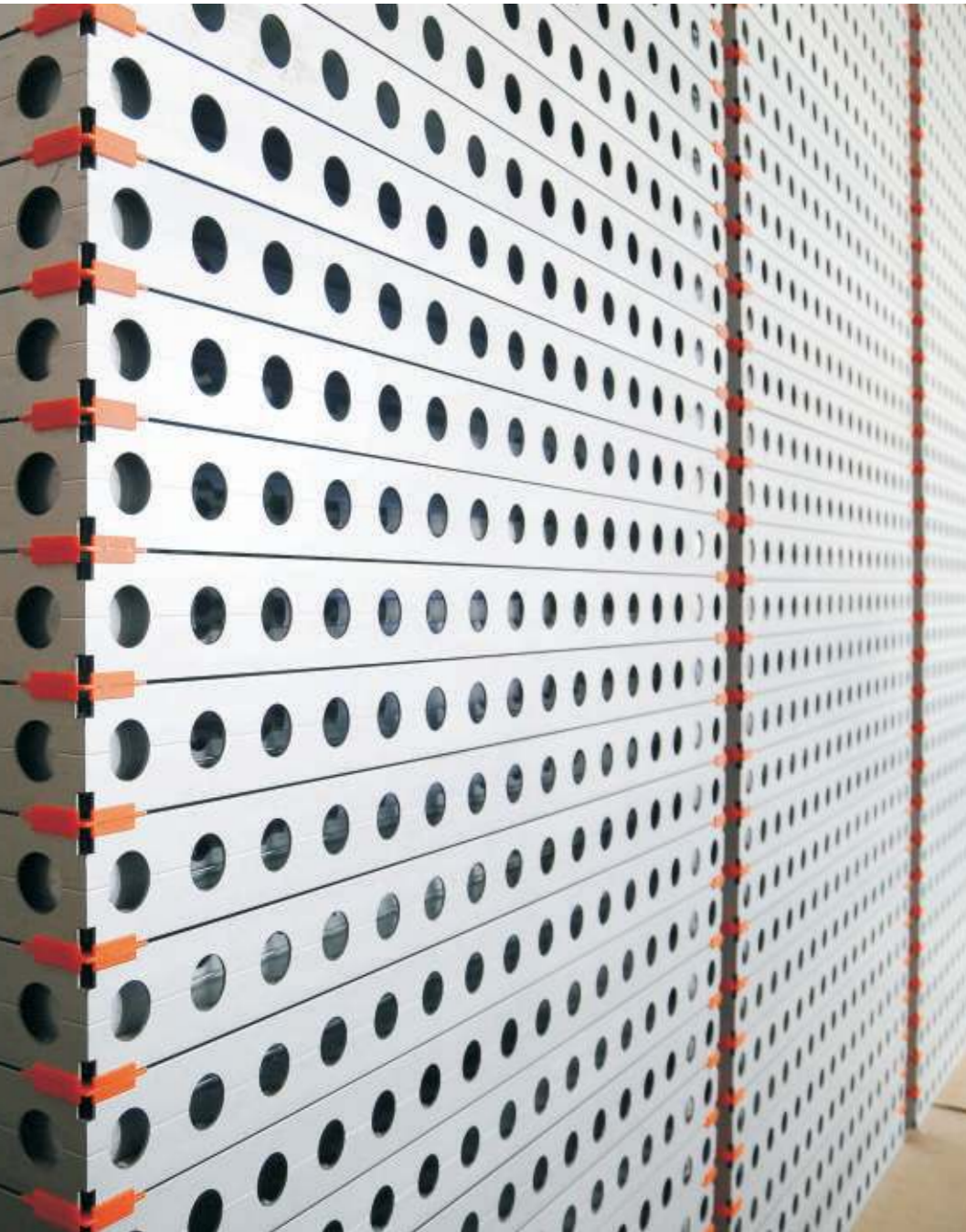

M-SERIES



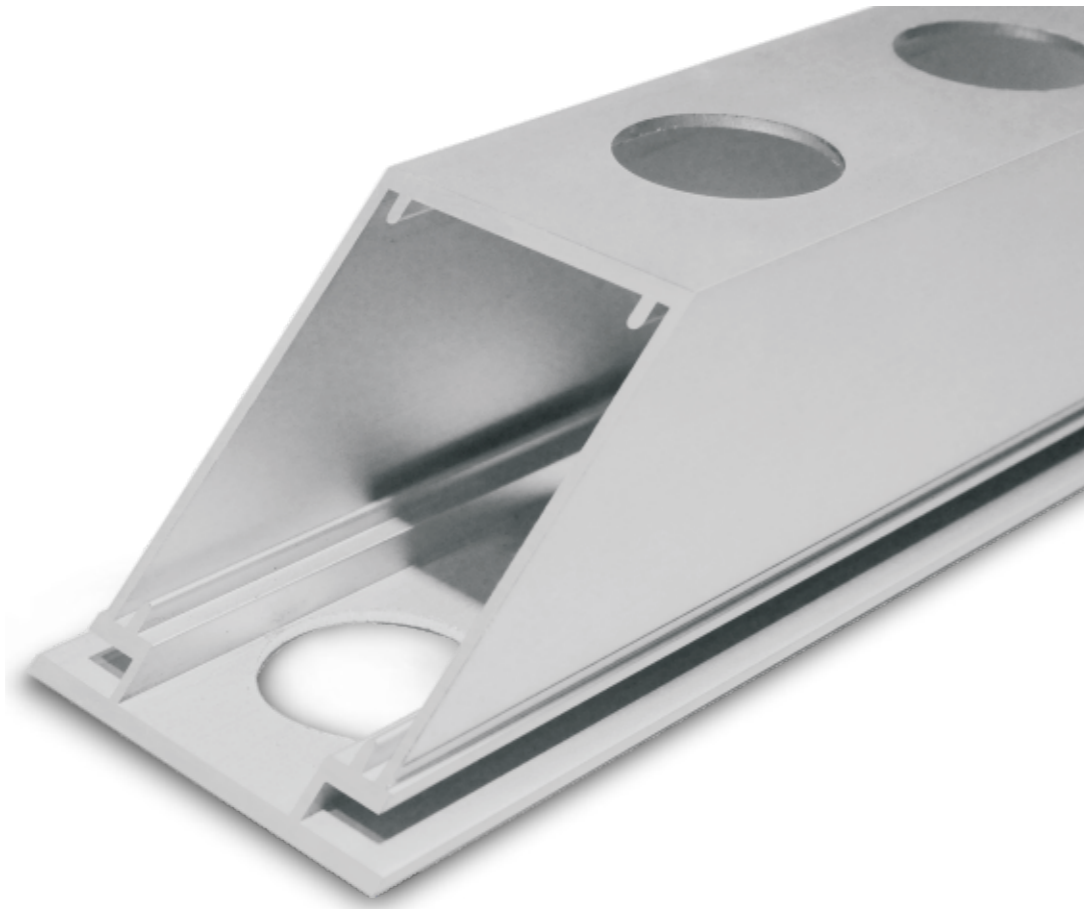

M-SERIES BY EXPOSURE SYSTEMS

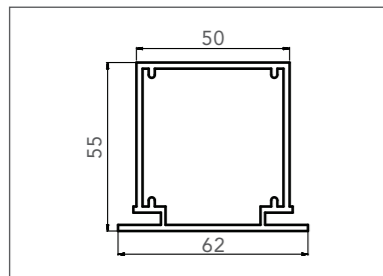
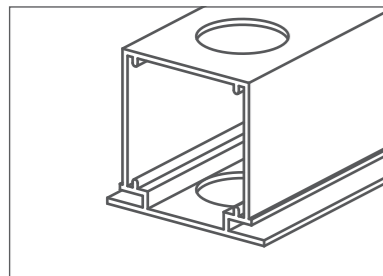

This modular product group comprises a wide range of standardized sizes with straight and curved frames. Virtually any format or exhibition stand size can be realized by combining different sizes and shapes. Our products usually serve as base components in stand design, but they may complement your existing structure as well.

These frames feature highly distinctive rounded recesses at the exterior of the frame. These recesses are milled at precise distances and have the exact same diameter, simplifying solid connections between the different frames. Our selection of connectors enables rapid and constructive assembly of any combination desired.

FRAMES

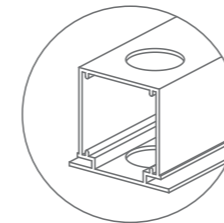

M-Series

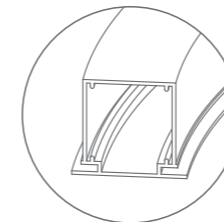

Curved series

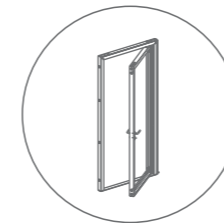

Door program

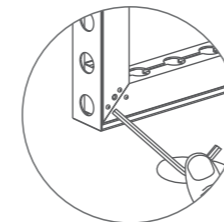

Assembling frame

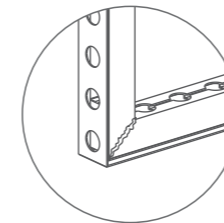

Permanent

VERSATILE

Our M-series has been developed to accommodate both panels and textile prints with a silicone strip, enabling endless variations with different materials to achieve the desired look. The M-series consists of double-sided frames and can therefore be fitted with panels or textile prints on either side.

Production is precision work!

Each frame has the exact same measurements. Each hole is milled at the exact same position and has the correct diameter. Our frames are produced with the great precision that has become our pride and joy. Our state-of-the-art and computer-driven equipment is highly accurate and efficient. Still, we take no chances and inspect and test all frame parts individually.

Two versions

The M-series is available in two versions:

- ① Assembling range
- ② Permanent range

The Assembling range is fitted with our "Quick Lock" system, with which even inexperienced users are able to assemble any frame within 60 seconds, irrespective of its size. Professional users will transform separate frame parts into a robust frame in a matter of seconds. This assembly and disassembly option yields substantial savings on volume during transport and storage. Reducing the volume by up to 80% may enable huge cuts in transit time and cost.

The permanent range is very popular among exhibition stand builders and is widely used in permanent applications, for example in showcases and shop displays.

Modular simplicity

The modular nature of the frames, as well as the simplicity and diversity in sizes, underlie their success. The frames are solid but may feature delicate finishing touches with ornate borders and accessories. This comprehensive program offers infinite possibilities. Our product range comprises the following:

- Standardized frames - straight
- Standardized frames - curved
- Door program
- Accessories
- Durable

Our products are durable, thanks to their solid workmanship and may be used in your stand designs time and again. The frames are durably produced as well, from a pure – though recycled – aluminum alloy. Recycled aluminum is far more environmentally friendly than unused aluminum extracted from bauxite. Any frames that are no longer reusable, for example because they are damaged, are 100% recyclable.

Inspired?

If the many options that Exposure System's M-series features appeal to you, please feel free to make an appointment with your supplier to see the actual product and try it out.

SIZE PARAMETERS

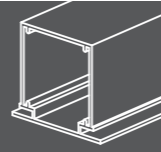

ARTICLE NUMBER	REFERENCE	DRAWING	DESCRIPTION
AHFS-310x310 AHFS-310x496 AHFS-310x992 AHFS-496x496 AHFS-496x992 AHFS-496x1240 AHFS-496x1488 AHFS-496x1984 AHFS-496x2480 AHFS-496x2976 AHFS-992x992 AHFS-992x1240 AHFS-992x1488 AHFS-992x1984 AHFS-992x2480 AHFS-992x2976			Available sizes 310x310mm 992x992mm 310x496mm 992x1240mm 310x992mm 992x1488mm 496x496mm 992x1984mm 496x992mm 992x2480mm 496x1240mm 992x2976mm 496x1488mm 496x1984mm 496x2480mm 496x2976mm

DHFS-992x1984 DHFS-992x2480 DHFS-992x2976 DHFC-992x1984 DHFC-992x2480 DHFC-992x2480			Available doors 992x1984mm 992x2418mm 992x2480mm 992x2976mm
--	--	--	--

AHFC-774x310mm (R 500) AHFC-774x496mm (R 500) AHFC-774x992mm (R 500) AHFC-774x1488mm (R 500) AHFC-774x1984mm (R 500) AHFC-774x2480mm (R 500) AHFC-774x2976mm (R 500)		Height 310 496 992 1488 1984 2480 2976 	Anodized aluminum curved frame R 500, 774x310mm R 500, 774x496mm R 500, 774x992mm R 500, 774x1488mm R 500, 774x1984mm R 500, 774x2480mm R 500, 774x2976mm
--	--	---	---

AHFC-776x310mm (R 1000) AHFC-776x496mm (R 1000) AHFC-776x992mm (R 1000) AHFC-776x1488mm (R 1000) AHFC-776x1984mm (R 1000) AHFC-776x2480mm (R 1000) AHFC-776x2976mm (R 1000)		Height 310 496 992 1488 1984 2480 2976 	Anodized aluminum curved frame R 1000, 776x310mm R 1000, 776x496mm R 1000, 776x992mm R 1000, 776x1488mm R 1000, 776x1984mm R 1000, 776x2480mm R 1000, 776x2976mm
---	--	---	--

ARTICLE NUMBER	REFERENCE	DRAWING	DESCRIPTION
AHFC-1165x310mm (R 1500) AHFC-1165x496mm (R 1500) AHFC-1165x992mm (R 1500) AHFC-1165x1488mm (R 1500) AHFC-1165x1984mm (R 1500) AHFC-1165x2480mm (R 1500) AHFC-1165x2976mm (R 1500)		Height 310 496 992 1488 1984 2480 2976 	Anodized aluminum curved frame R 1500, 1165x310mm R 1500, 1165x496mm R 1500, 1165x992mm R 1500, 1165x1488mm R 1500, 1165x1984mm R 1500, 1165x2480mm R 1500, 1165x2976mm

AHFC-1167x310mm (R 3000) AHFC-1167x496mm (R 3000) AHFC-1167x992mm (R 3000) AHFC-1167x1488mm (R 3000) AHFC-1167x1984mm (R 3000) AHFC-1167x2480mm (R 3000) AHFC-1167x2976mm (R 3000)		Height 310 496 992 1488 1984 2480 2976 	Anodized aluminum curved frame R 3000, 1167x310mm R 3000, 1167x496mm R 3000, 1167x992mm R 3000, 1167x1488mm R 3000, 1167x1984mm R 3000, 1167x2480mm R 3000, 1167x2976mm
--	--	---	---

ACS.02.00.02

90 Degrees connector.
Used per set of 2 pcs (floor & top).

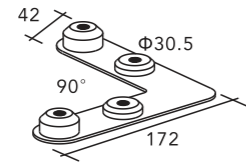

ACS.02.00.03

3 Way connector
90 Degrees connector.
Used per set of 2 pcs (floor & top).

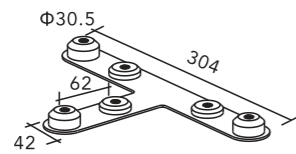

ACS.02.00.05

Y connector
Used per set of 2 pcs
(floor & top)

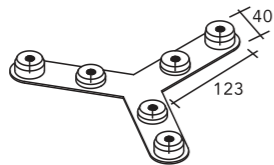

ACS.05.00.02

180 Degrees base foot
Basefoot incl. 180 Degrees connector
Size: 400x62x10 MM 180
Material: Steel/ aluminium

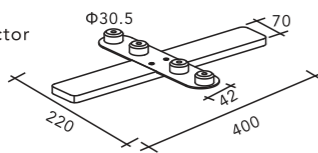

ACS.02.02.02

Pin connector

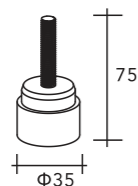

ACS.02.00.01

180 Degrees connector.
Used per set of 2 pcs (floor & top).

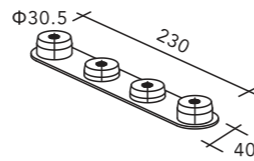

ACS.02.00.04

X connector
90 Degrees connector.
Used per set of 2 pcs
(floor & top).

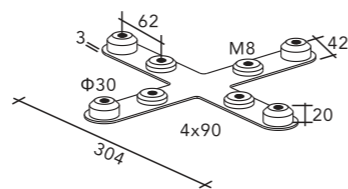

ACS.02.00.06

Flexible connector
Used per set of 2 pcs
(floor & top)

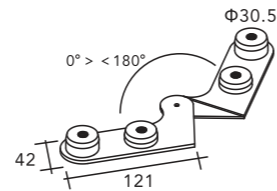

ACS.05.00.01

180° Side foot
Sidefoot
Size: 400x62x10 MM 180
Material: Steel/ aluminium

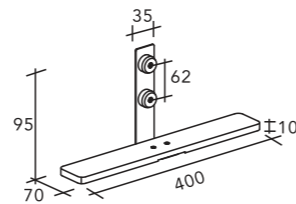

ACS.02.02.04

Door pin connector standard

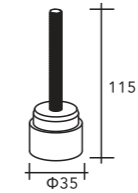

ACS.02.02.05

Door pin connector long

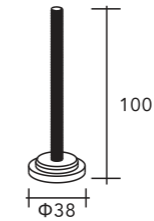

ACS.02.01.06

The door 90 degrees connector

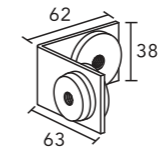

ACS.02.02.01

Used to connect individual frames on
horizontal or vertical level. Used with
a minimum per 2 pcs per connection.

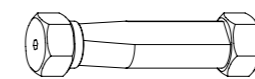

ACS.02.02.03

Pin connector used with cover

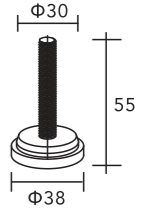

ACS.02.02.06

Flat wheelnut

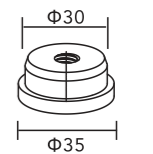

ACS.02.01.07

The door 90 degrees connector

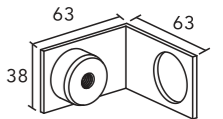

ACS.06.02.01

LED design spot

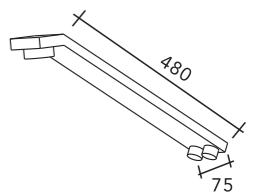

ACS.03.01.01

Shelf Kit
Set shelf kit. Left and right,
steel model. Excl. top.

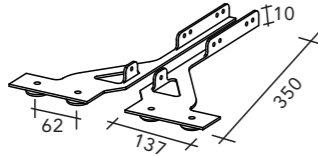

ACS.03.01.03

Shelf Kit

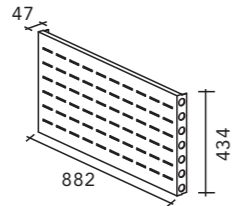

ACS.03.01.05

TV Kit
Per set of 2 pcs

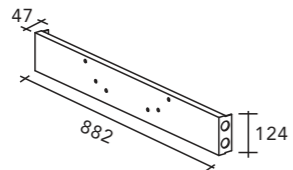

ACS.04.02.01

Clip connector
Clip cover connects cover profile
to the straight line and curved
frame range

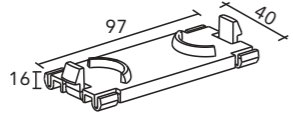

ACS.04.02.10

3M Velcro Hook(frame)
grey,25mm wide
on a 25 meter roll

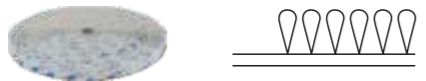

ACS.03.01.02

Shelf Kit

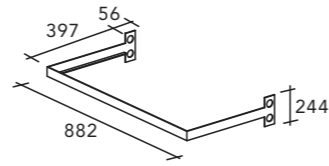

ACS.03.01.04

Clothing hanger(used in
combination with article ACS.03.01.03)

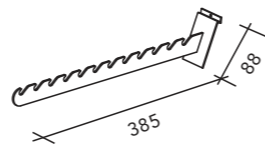

ACS.04.02.02

Cover profile, bar per 6100 MM
Cover profile, flat model.
Extruded 6100 MM, standard anodized
Need to be connected to the frame with
model ACS.09.01.00

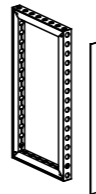

ACS.07.02.01

Frame Protector

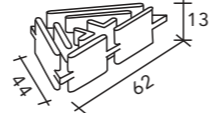

ACS.04.02.11

3M Velcro loop (panel/ sheet)
grey,25mm wide
on a 25 meter roll

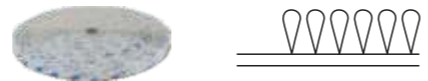

Accessories combination

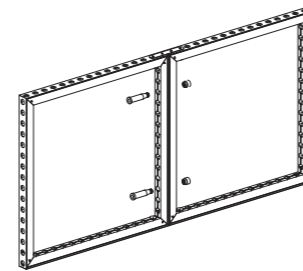

180 degrees frame connector

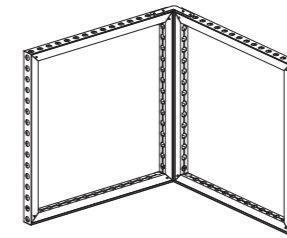

90 degrees frame connector

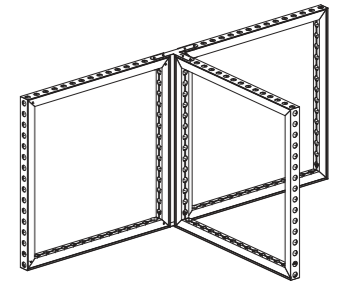

3 Way frame connector

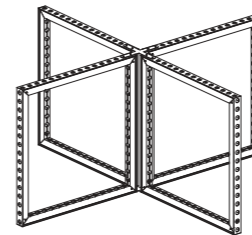

X frame connector

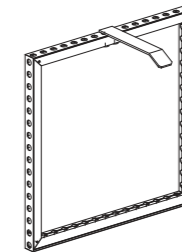

LED design spot

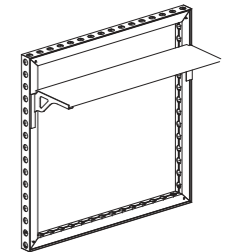

Shelf Kit

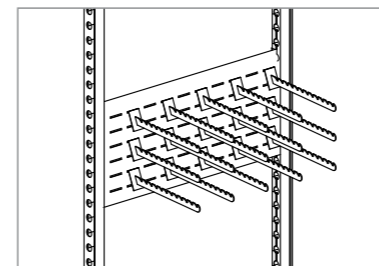

Shelf Kit

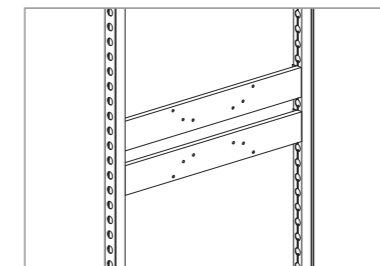

TV Kit

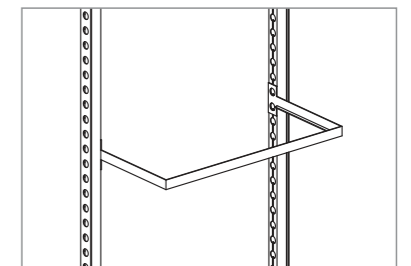

Shelf Kit



THE DOOR SYSTEM



Solid doors for creating meeting and storage rooms in your booth.

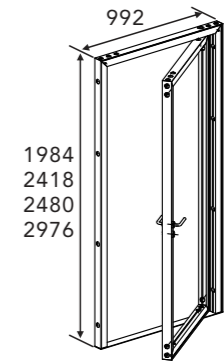

Standard width: 992 mm
Standard height: 1984, 2418, 2480, 2976mm



Intergrated lock



Lock part for "push in" or "push out" directions.



Complete lock assembly

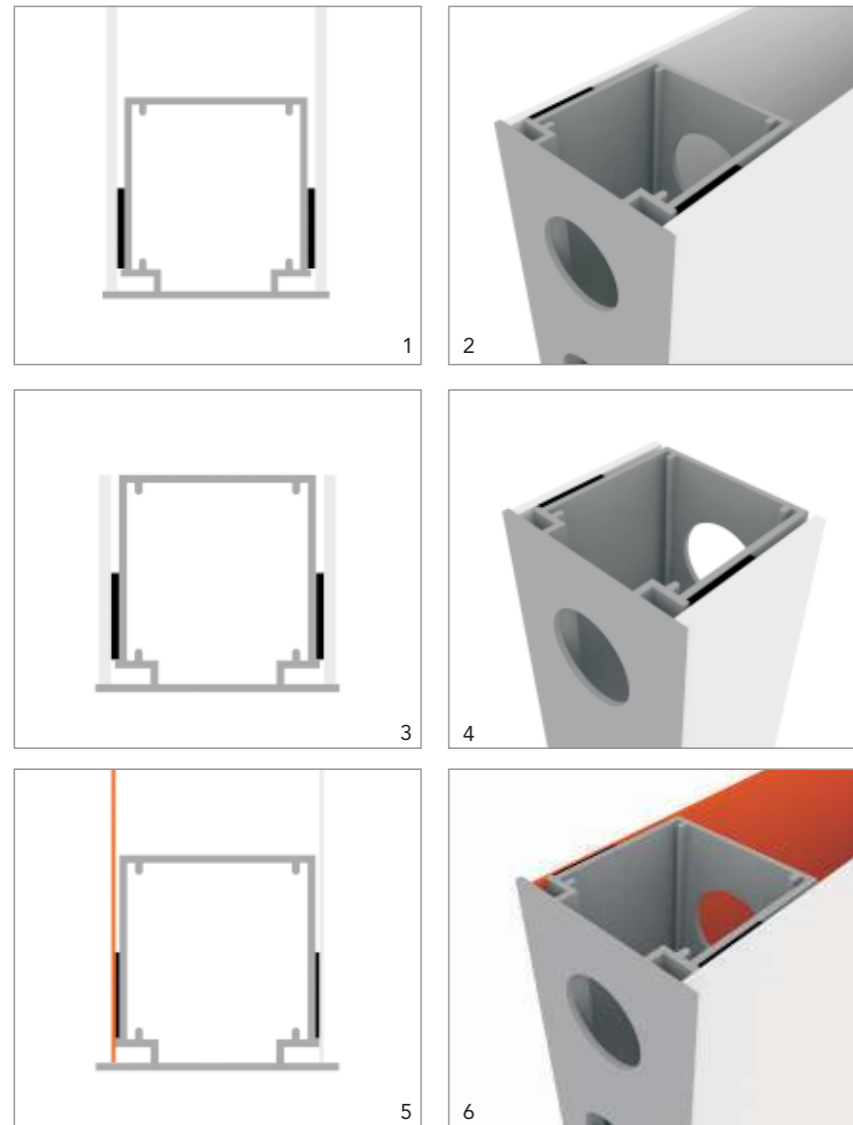

Use a stiff material. Dibond / sandwich panels are more suitable than forex or carton.



THE BOOTH SYSTEM



